

| AMERICAN STANDARD



ASIENTO ELONGADO

Asiento Elongado

Elongate Seat

Ref 07000139.color

Ficha Técnica

Cut Sheet

ASIENTO ELONGADO

Asiento Elongado / Elongate Seat











Información técnica

Technical Information

Material Material	100% polipropileno 100% polypropylene
Dimensiones (An x L x AL) Dimensions (L x L x H)	- cms. - cms.
Peso Weight	1.00 kg 1.00 kg
Incluye Items included	Tuercas y bisagras Nuts and hinges

Color

Color

 Blanco .020 White .020	 Bone .021 Bone .021
 Gris .165 Grey .165	 Negro .178 Black .178
 Azul .209 Blue .209	 Logan Berry .210 Logan Berry .210
 Day dream .225 Day dream .225	 Candle light .202 Candle light .225
 Light Mink .190 Light Mink .190	 Spring .227 Spring .227
 Verde Tropical .211 Green Tropical .211	

Cuidados y limpieza

Attendance and cleanliness

Los acabados superficiales son aquellos que le imprimen una apariencia especial y estética a su producto y además le brindan protección.

Para prolongar sus cualidades es vital que la limpieza profunda del producto se haga únicamente con agua y jabón suave y que en el secado y el brillo se utilice un paño de algodón limpio; Por ningún motivo deben usarse elementos abrasivos, ácidos o disolventes para la limpieza del producto.

Surface finishes are those that give an appearance special and aesthetic to your product and also provide protection.

To prolong its qualities it is vital that the deep cleaning of the product is done only with water and mild soap and that in drying and shine it is used a clean cotton cloth; For no reason should they use abrasive elements, acids or solvents for cleaning the product.

Plano técnico

Technical Drawing

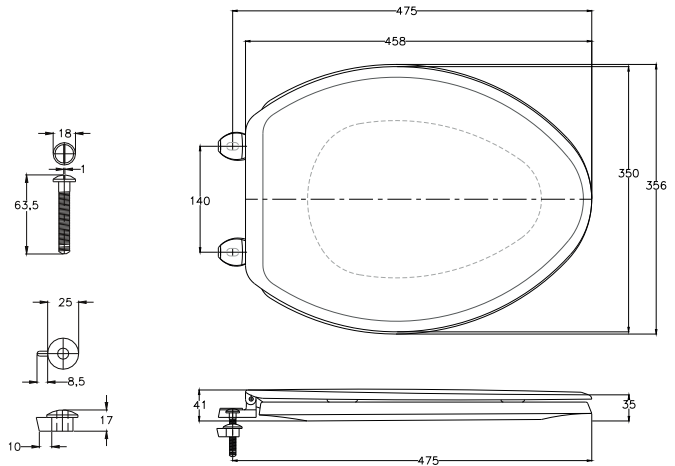

GARANTÍA DE 5 AÑOS PRODUCTO,
LIMITED WARRANTY 5 YEARS IN PRODUCT.



SERVICIO POST VENTA
AFTER SALE SERVICE

Panamá: (507) 800-0202
 Costa Rica: (506) 4001-4966
 Guatemala: (502) 1800-6240-109
 Honduras, San Pedro Sula: (504) 9482-6710
 Honduras, Tegucigalpa: (504) 9767-0821
 Nicaragua: (505) 2249-5521
 El Salvador: (503) 2274 4620
postventa@incesastd.com

PISO TERMINADO / FINISHED FLOOR

Unidades / Units: mm.

Estas dimensiones son nominales y son sujetas a cambio sin previo aviso.
These dimensions are nominal and are subject to change without prior notice.